

Rozmery v mm; Maße in mm

OVALIS 05 KERAMIKA-183A

138 kg

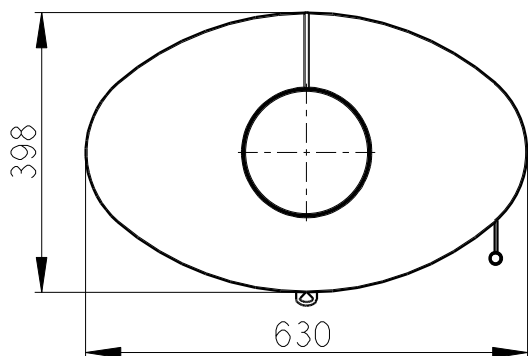
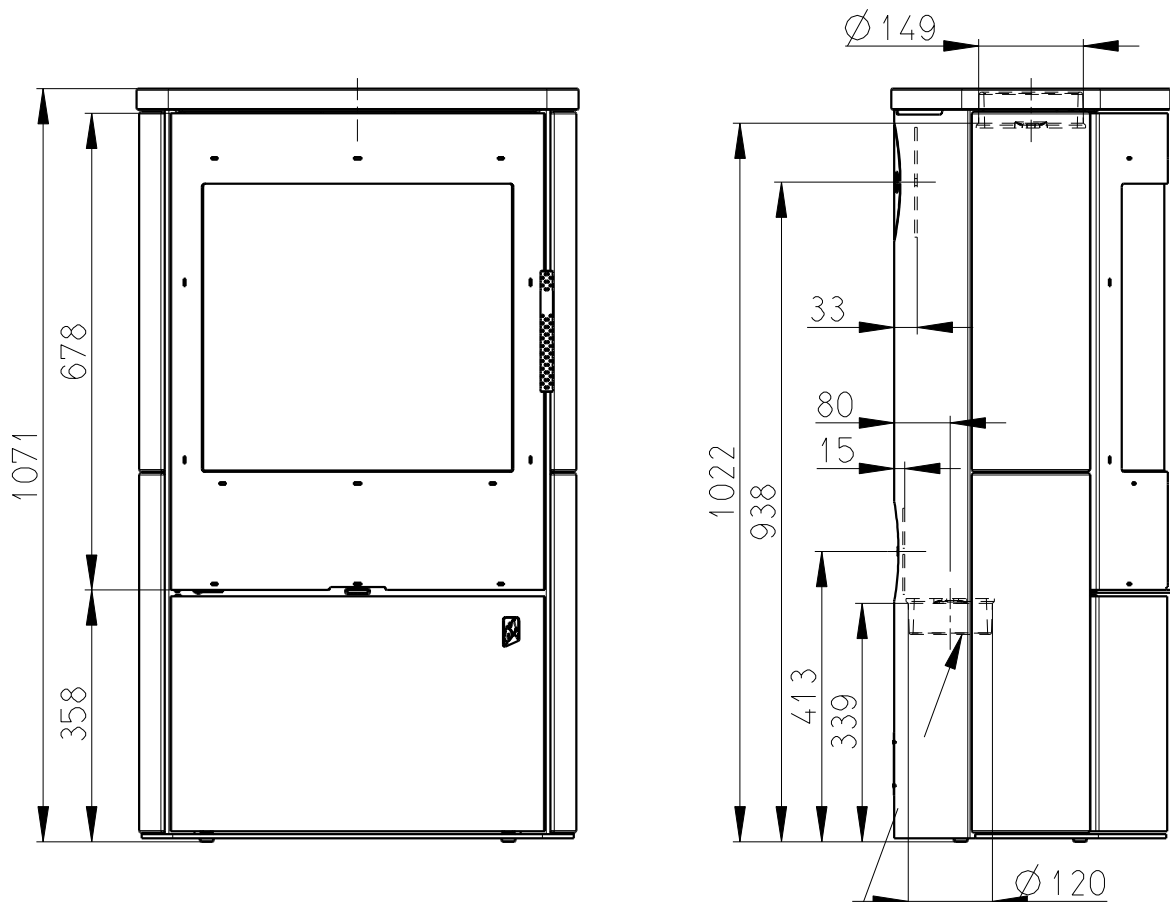

Centralni privod vzduchu Ø 120
Zentral luftzufuhr Ø 120
Central air inlet Ø 120

Primarni a sekundarni vzduch
Primarluft und sekundarluft
Primary and Secondary air

